

Installation and Operating Instructions

VPS / VPS H / VPS DSM / VPS plus / VPS RF Wall



Types:

- VPS 1000
- VPS 1200
- VPS 1500
- VPS 2000
- VPS H 1000
- VPS H 1200
- VPS DSM 1000
- VPS DSM 1200
- VPS DSM 1500
- VPS DSM 2000
- VPS RF 1000
- VPS RF 1200
- VPS RF 1500
- VPS RF 2000
- VPS plus 1000
- VPS plus 1200
- VPS plus 1500
- VPS plus 2000



Please read attentively and keep in a safe place!

Subject to alterations!

Id_no. 911 360 870

Issue 08/18

1. General information about our surface storage heaters

With our variety of electric surface storage heaters, you can find the right solution for your needs in any spatial situation. The TECHNOTHERM partial thermal-storage heaters are available as additional or transitional heating for all rooms in the living area, with the exception of the special cases stated in the safety instructions. They are designed for continuous operation. Prior to dispatch, all our products undergo an extensive function, safety and quality test. We guarantee a constructive design complying with all currently applicable international, European and German safety standards and rules. You can see this in the labelling of our products with the well-known certification marks: “TÜV-GS”, “SLG-GS”, “Keymark” and “CE”. Our heaters are evaluated in accordance with the internationally applicable IEC-regulations. The manufacture of our heaters is constantly supervised by a state-accredited test centre.

This heater can be used by children aged from 8 years and above and by physically, sensory or mentally restricted persons if they are supervised or given instructions on safe use and understand the hazards involved as it does not require any experience or knowledge. This device is not a toy for children to play with! Cleaning and user maintenance shall not be carried out by children without supervision. The use of heat radiators is to be given a particular duty of care by supervisors. Children under the age of 3 are to be kept away unless they are continually supervised. Children between the age of 3 and 8 are only allowed to switch the heater on or off if they are supervised or given instructions on safe use and understand the hazards involved, provided that it has been placed or installed in its intended normal operating position. Children between the age of 3 and 8 shall not plug in, regulate and clean the heater or perform user maintenance.

Caution: Some parts of the product can become very hot and cause burns. Pay particular attention when children and vulnerable people are present

Warning! this device has to be grounded

This device may only be operated using alternating current and the operating voltage indicated on the power rating plate

- Nominal Voltage 230V AC, 50 Hz
- Protection Class I
- Degree of Protection IP 24
- Room Thermostat 7°C till 30°C

2.1 User Manual VPS RF Model

2.1.1 Setting the Room Thermostat

Press the **receiver button** for more than 3 seconds, until the indicator light begins to flash. Subsequently press the transmitter key in the configuration mode. (see User Manual Receiver) As soon as the indicator light stops flashing the two products are assigned.

2.1.2 Setting the sender

Press the receiver button for at least 3 seconds until the indicator light starts flashing. Two modes of operation are possible.

Slow flashing: On\Off switch

Fast flashing: instigator

To switch the mode again, press the key briefly. Take the transmitter into the Configuration mode (see user manual transmitter). Check that the indicator light is no longer flashing.

Application Example

The use of a room thermostat in combination with a opening detector is ideal, because the opening detector will detect if a window is open and will automatically switch to frost protection. By pressing the receiver button for approximately 10 seconds, you can change the relay's setting. You know the setting is changed as soon as the signal light stops flashing.

2.1.3 Deleting Allocations

To delete the setting simply press the receiver key for approximately 30 seconds until you see the receiver light flash briefly. All transmitters are now deleted.

2.1.4 Receiver RF- Technical Specifications

- Power Supply 230 V, 50 Hz +/-10%
- Protection Class II
- Expenditure : 0,5 VA
- Switching capacity max.: 16 A 230 Veff Cos j =1 or max. 300 W with lighting control
- Radio Frequency 868 MHz (NormEN 300 220),
- Radio Range up to 300 m in an open field, indoors up to ca. 30m, depending on the construction of the building and the electromagnetic interference
- Maximal Number of receivers: 8
- Mode of operation: type 1.C (Micro-disconnection)
- Operating Temperature: -5°C to +50°C
- Storage Temperature: -10 °C +70°C
- Dimensions: 120 x 54 x 25 mm
- Degree of Protection : IP 44 - IK 04
- To be installed in average polluted Areas4. Installation DSM Thermoostat / DAS Schnittstelle.

VPS devices

WARNING

Do not install this device in areas that present an explosion hazard like a garage. Remove all protective coverage before turning on the device. When using the device for the first time you might detect a strong odor. This is no reason for concern; it is caused by residues of production and will disappear shortly.

The rising heat may cause stains on the ceiling, however this phenomena can be caused by any other heating device as well. Only a qualified electrician may open or remove the device from the power supply.



3. User Manuel for the VPS DSM

Please see additional manual at www.lucht-lhz.de/lhz-app-gb.html and download the manual

4. Maintenance

Before cleaning the device be sure to turn it off. To clean use a damp towel and a mild detergent.

GB

VPS devices

5. Details for operation of Types VPS plus /VPS H plus/VPS TDI

Digital control display

TDI – “plus” Thermostat

Mounting

Mounted on the side of the radiator using screws.

Connection

Connection on the radiator's power card.

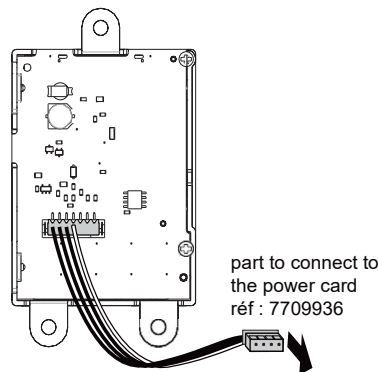
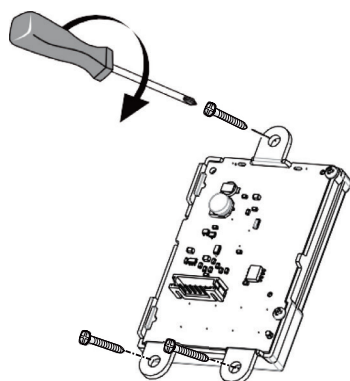
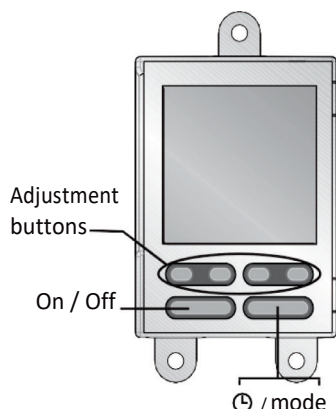

Configuration

When in Off mode, press and hold down the On/Off button for 10 seconds to access the first configuration menu.

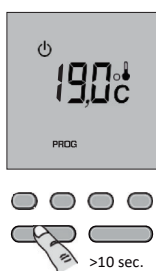

Menu 3: Backlight time out setting

The time out can be adjusted between 0 and 225 seconds, in steps of 15 seconds (set on 90 seconds by default). To modify, press on the + or - buttons then press OK to confirm and go to the next setting.

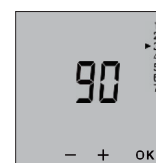

Menu 1: ECO set-point adjustment

By default, Economy setting = Comfort setting - 3.5°C.

This reduction can be set between 0 to -10°C, in steps of 0.5°C.

To adjust the reduction, press on the + or - buttons then press OK to confirm and go to the next setting.

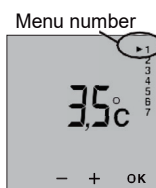

Menu 4: AUTO mode temperature display option

0 = Continuous display of room temperature.
1 = Continuous display of set-point temperature.
To modify, press on the + or - buttons then press OK to confirm and go to the next setting.

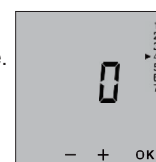

To allow the user to modify the set-point, press on the + button in Economy mode until "----" is displayed on the screen.

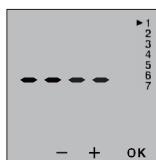

Menu 5: Product number

This menu allows you to view the product number.

To exit the configuration mode, press OK.



Menu 2: Correction of the measured temperature

If there is a difference between the temperature noted (thermometer) and the temperature measured and displayed by the unit, menu 2 acts on the measurement of the probe so as to compensate for this difference (from -5°C to +5°C in steps of 0.1°C).

To modify, press on the + or - buttons then press OK to confirm and go to the next setting.



VPS devices

Time Setting

In Off mode, press the mode button.

The days flash.

Press + or - to set the day, then press OK to confirm and go on to set the hour and then the minutes.



Press the mode button once to access the programming, and press the On/Off button once to exit the setting mode.

Programming

When starting up, the "Comfort mode from 8am to 10pm" program is applied to all the days of the week.

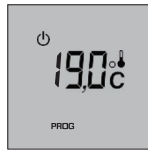

To change the programming, press the PROG button in Off or AUTO mode.

The 1st time slot flashes on and off.

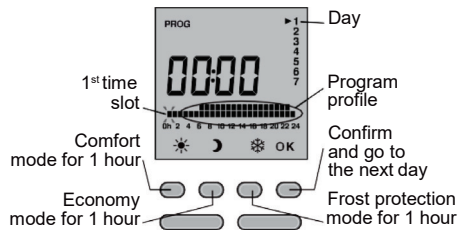

Quick programming:

To apply the same program to the following day, press and hold the OK button for approximately 3 seconds until the program of the following day is displayed.

To exit the programming mode, press on the On/Off button.

Use

The Mode button allows you to select the different operating modes: ☀ Comfort, 🌙 Economy, ❄ Frost protection, programming AUTO mode.

Pressing the **i** button gives you the temperature of the room or the set-point temperature, according to your configuration settings in menu 5.

If the **ON** icon is displayed, this means that the device is in heating demand mode.

Continuous Comfort

Pressing and holding the + or - buttons lets you change the current set-point (+5 to +30°C) in steps of 0.5°C.

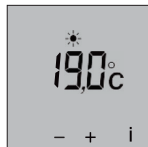

Continuous Economy mode

The Economy set-point is indexed according to the Comfort set-point. The reduction can be modified in the configuration settings for menu 1.



Modifying the Economy set-point

The set-point can be modified if it was authorized in the configuration settings in menu 1 ("----").

Pressing and holding the + or - buttons lets you change the current set-point (+5 to +30°C) in steps of 0.5°C.



Use

Continuous Frost Protection

Pressing and holding the + or - buttons lets you change the current set-point (+5 to +15°C) in steps of 0.5°C.

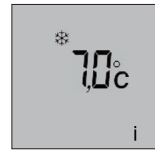

AUTOMATIC mode

In this mode the device follows the programming set.

To modify the programming, press the PROG button once.

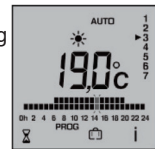

Timer mode

To set a set-point temperature for a certain period of time, press on the ⌚ button once.

To set the temperature you want (+5°C to +30°C), use the + and - buttons, then press OK to confirm and go on to set the duration.

To set the duration you want (30 min to 72 hours, in steps of 30 min), use the + and - buttons (e.g. 1 hr 30 min), then press OK. To cancel the timer mode, press on the OK button.



Absence mode

You can set your device to Frost protection mode for a period between 1 and 365 days, by pressing on the 📅 button.

To set the number of days of absence, press on the + or - buttons, then confirm by pressing OK.

To cancel this mode, press on the OK button again.

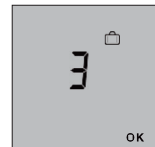

Locking the keypad

If you press and hold the central buttons simultaneously during 5 seconds, it enables you to lock the keypad. A key symbol appears briefly on the display.

To unlock the keypad, press simultaneously on the central buttons.



Once the keypad is locked, the key symbol appears briefly if you press on a button.

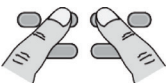

Menu 5: Open Window detection

The detection of an open window occurs when the room temperature falls rapidly. In this case, the display shows a flashing ❄ pictogram, as well as the frost protection set-point temperature.

0 = Open window detection is deactivated
1 = Open window detection is activated

To modify, press on the + or - buttons, then press OK to confirm and to go to the next setting.

Please note: an open window cannot be detected in OFF-Mode. This feature can be temporarily interrupted by pressing on ❄.



Installation and Operating Instructions

VPS devices

Menu 6: Adaptive start control

This feature enables to reach the set-point temperature at a set time.

When this feature is activated, the display shows a flashing ✱.

0 = Adaptive start control deactivated

1 = Adaptive start control activated

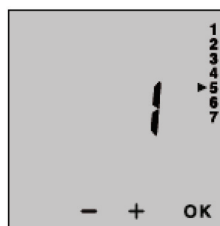

To modify, press on the + or – buttons, then press OK to confirm and to go to the next setting.

Adjusting the time-temperature-slope (when adaptive start control is activated)

From 1°C to 6°C, in steps of 0.5°C.

If the set-point temperature is reached too early, then a lower value should be set.

If the set-point temperature is reached too late, then a higher value should be set.

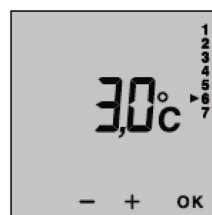

GB

Menu 7: Productnumber

This menu allows you to view the product number.

To exit the configuration mode, press OK.



Technical characteristics

- Power supplied by the power card
- Dimensions in mm (without mounting lugs):
H = 71.7, W = 53, D= 14.4
- Screw-mounted
- Install in an environment with normal pollution levels
- Storage temperature: -10°C to +70°C
- Operating temperature: 0°C to +40°C

VPS devices

6.1 Assembly instruction

This Manual is very important and has to be kept at a safe place at all times. Be sure to hand this manual to any other succeeding owner of the device. The device comes with a power plug that has to be plugged into an outlet.

The device is designed to be connected to 230V (nominal) alternating current (AC).

7.1 Wall Installation

When installing the device, the safety distance must be strictly adhered to, so that flammable materials can not ignite. Install the device to a wall which is heat resistant up to 90 ° C.

- Due to possible fire hazard the safety distances are observed during assembly:

Side walls of the heater to any masonry:	5 cm
Side walls of the heater to combustible materials:	10 cm
Distance radiator to the floor:	25 cm
arranged spaced upper radiator limit to about components or covers (. Eg window):	
flammable	15 cm
nonflammable	10 cm

To prevent inflammable materials from catching fire be sure to keep the prescribed safety distance when installing the device. Mount the device to a wall that is fireproof up to 90 °C.

The safety distance to the floor should be 25 cm, and at least 10 cm to all other devices. Furthermore there has to be safety distance of approximately 50 cm between the ventilation grille, windowsills, roof slopes and ceilings.

If you want to install the device in your bathroom, be sure to keep it out of reach for people taking a shower or a bath.

When mounting the device to the wall, be sure to keep to the dimensions as indicated in the illustration on page 11. Drill two or three (if available) 7 mm holes and attach the corresponding plug. Then screw the 4 x 25 mm screws into the holes, leaving a distance of 1-2mm between the head of the screw and the wall.

Hang the device in the two or three fittings and tighten it down. See also the additional mounting information at the following pages!



VPS devices

8.2 Wall Mounting

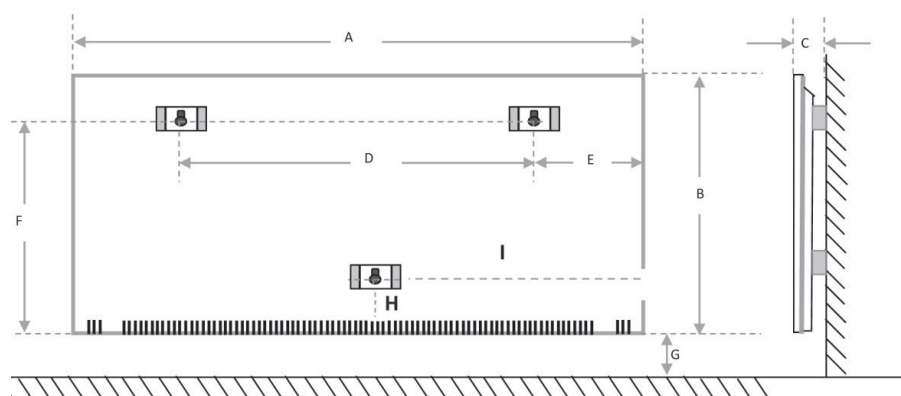

GB

Type	Power [Watt]	With A	High B	Deep C	[mm] D	[mm] E	[mm] F	[mm] G	[mm] H	[mm] I	Weight [kg]
VPS 1000	1000	750	450	85	442	140	375	250	115	375	11,5
VPS 1200	1200	750	450	85	442	140	375	250	115	375	11,5
VPS 1500	1500	1050	450	85	740	140	375	250	115	525	15,0
VPS 2000	2000	1050	450	85	740	140	375	250	115	525	15,0

VPS devices

9. Installation of Electricity

The device was developed for an electrical voltage of 230 V(nominal) and an alternating current of (AC) 50 Hz. The electrical installation may only be performed according to the user manual and only by a qualified Electrician. The device was designed to be used with termination and the connection cable has to be plugged into an appropriate socket at all times. (Notice Permanent cables may not be used) The distance between the receptacle and the device has to be at least 10cm. The connection line may not touch the device at any time.

10. Regulation

From 01.01.2018, the EU conformity of these devices is additionally linked to the fulfillment of the Ecodesign requirements 2015/1188.

The installation and commissioning of the devices is only permitted in conjunction with external room temperature controllers that fulfill the following functions:

- electronic room temperature control

and has at least one of the following properties:

- room temperature control, with presence detection
- room temperature control, with open window detection
- with distance control option
- with adaptive start control

The following room temperature controller systems

- RF Receiver together with the TPF-Eco Thermostat (Art.Nr.: 750 000 641) and the Eco-Interface (Art.Nr.750 000 640) or
- DSM-Thermostat with the DSM-Interface (Art.No.:911 950 101)
- TDI- Thermostat / plus-Thermostat

from Technotherm meet the following requirements and therefore the ErP Directive:

- electronic room temperature control plus week timer (RF/DSM/TDI)
- room temperature control, with open window detection (DSM/plus/TDI)
- with distance control option (DSM/RF)
- with adaptive start control (DSM/plus/TDI)

Use of the VPS / VP Standard range (without external/internal thermostat control) is only permitted on feet.

Installation of the receiver and the interfaces see separate instructions. For customer service - see last page.

Failure to comply with these requirements will result in the loss of the CE mark.

VPS devices

9. Additional wall mounting information

1. Drill three holes of 7mm and fix the wall bracket. Screw in the three 4 x 25 mm screws into the wall
2. Click the heater first at the top into the wall bracket and then at the bottom. The heater will be fixed "automatically".

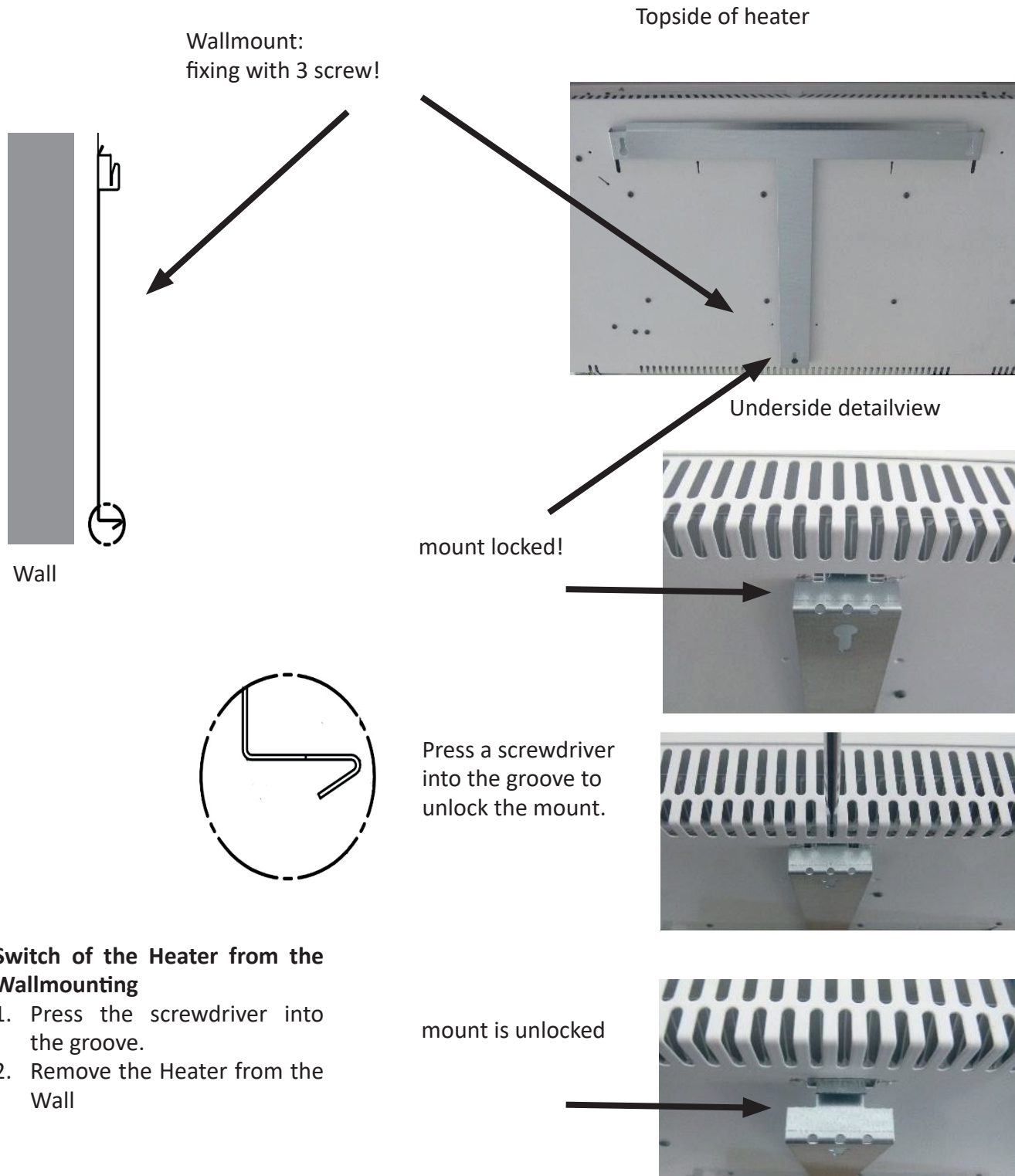

Switch of the Heater from the Wallmounting

1. Press the screwdriver into the groove.
2. Remove the Heater from the Wall

VPS devices

11. Information requirements for electrical local space heaters

Type: VPS RF (additional TPF Thermostat and Eco-Interface optionally necessary) / VPS plus							RF	plus	
Item	Symbol	Value				Value	Item	Value	
Heat output							Type of heat input, for electric storage local space heaters only (select one)		
Nominal heat output	P _{nom}	1000	1200	1500	2000	Watt	manual heat charge control, with integrated thermostat	NO	NO
Minimum heat output (indicative)	P _{min}	1000	1200	1500	2000	Watt	manual heat charge control with room and/or outdoor temperature feedback	NO	NO
Maximum continuous heat output	P _{max,c}	1000	1200	1500	2000	Watt	electronic heat charge control with room and/or outdoor temperature feedback	NO	NO
Auxiliary electricity consumption							fan assisted heat output	NO	NO
At nominal heat output	e _{l,max}	1000	1200	1500	2000	Watt	Type of heat output/room temperature control (select one)		
At minimum heat output	e _{l,min}	2.0	2.0	2.0	2.0	Watt	single stage heat output and no room temperature control	NO	NO
In standby mode	e _{l,SB}	<0,5	<0,5	<0,5	<0,5	Watt	Two or more manual stages, no room temperature control	NO	NO
							with mechanic thermostat room temperature control	NO	NO
							with electronic room temperature control	NO	NO
							electronic room temperature control plus day timer	NO	NO
							electronic room temperature control plus week timer	YES	YES
							Other control options (multiple selections possible)		
							room temperature control, with presence detection	NO	NO
							room temperature control, with open window detection	NO	YES
							with distance control option	YES	YES
							with adaptive start control	NO	YES
							with working time limitation	NO	NO
							with black bulb sensor	NO	NO



VPS devices



Type: VPS								
Item	Symbol	Value				Value	Item	Value
Heat output							Type of heat input, for electric storage local space heaters only (select one)	
Nominal heat output	P_{nom}	1000	1200	1500	2000	Watt	manual heat charge control, with integrated thermostat	NO
Minimum heat output (indicative)	P_{min}	1000	1200	1500	2000	Watt	manual heat charge control with room and/or outdoor temperature feedback	NO
Maximum continuous heat output	$P_{max,c}$	1000	1200	1500	2000	Watt	electronic heat charge control with room and/or outdoor temperature feedback	NO
Auxiliary electricity consumption							fan assisted heat output	
At nominal heat output	$e_{l,max}$	1000	1200	1500	2000	Watt	Type of heat output/room temperature control (select one)	
At minimum heat output	$e_{l,min}$	<0,5	<0,5	<0,5	<0,5	Watt	single stage heat output and no room temperature control	NO
In standby mode	$e_{l,SB}$	<0,5	<0,5	<0,5	<0,5	Watt	Two or more manual stages, no room temperature control	NO
							with mechanic thermostat room temperature control	NO
							with electronic room temperature control	YES
							electronic room temperature control plus day timer	NO
							electronic room temperature control plus week timer	NO
							Other control options (multiple selections possible)	
							room temperature control, with presence detection	NO
							room temperature control, with open window detection	NO
							with distance control option	NO
							with adaptive start control	NO
							with working time limitation	NO
							with black bulb sensor	NO

Type: VPS DSM (additional DSM interface optionally necessary)								
Item	Symbol	Value				Value	Item	Value
Heat output							Type of heat input, for electric storage local space heaters only (select one)	
Nominal heat output	P_{nom}	1000	1200	1500	2000	Watt	manual heat charge control, with integrated thermostat	NO
Minimum heat output (indicative)	P_{min}	1000	1200	1500	2000	Watt	manual heat charge control with room and/or outdoor temperature feedback	NO
Maximum continuous heat output	$P_{max,c}$	1000	1200	1500	2000	Watt	electronic heat charge control with room and/or outdoor temperature feedback	NO
Auxiliary electricity consumption							fan assisted heat output	
At nominal heat output	$e_{l,max}$	1000	1200	1500	2000	Watt	Type of heat output/room temperature control (select one)	
At minimum heat output	$e_{l,min}$	0,8	0,8	0,8	0,8	Watt	single stage heat output and no room temperature control	NO
In standby mode	$e_{l,SB}$	0,8	0,8	0,8	0,8	Watt	Two or more manual stages, no room temperature control	NO
							with mechanic thermostat room temperature control	NO
							with electronic room temperature control	NO
							electronic room temperature control plus day timer	NO
							electronic room temperature control plus week timer	YES
							Other control options (multiple selections possible)	
							room temperature control, with presence detection	NO
							room temperature control, with open window detection	YES
							with distance control option	YES
							with adaptive start control	YES
							with working time limitation	NO
							with black bulb sensor	NO

GB

TECHNOTHERM After-sales service:
Ph. +49 (0) 911 937 83 210

Technical alternations, errors, omissions and errata reserved. Dimensions are stated without warranty!

Updated: august 18

Technotherm is a label from Lucht LHZ GmbH & Co. KG
Reinhard Schmidt-Str. 1 | 09217 Burgstädt, Germany
Phone: +49 3724 66869 0
Telefax: +49 3724 66869 20
info@technotherm.de | www.technotherm.de