

Digital control display TDI – “plus” Thermostat

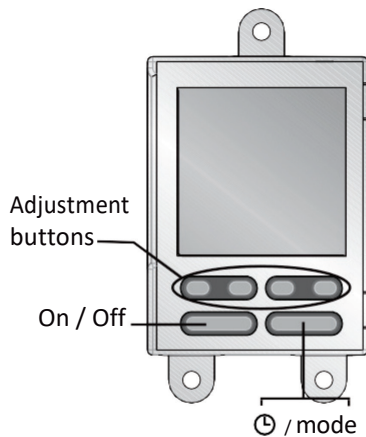

Mounting

Mounted on the side of the radiator using screws.

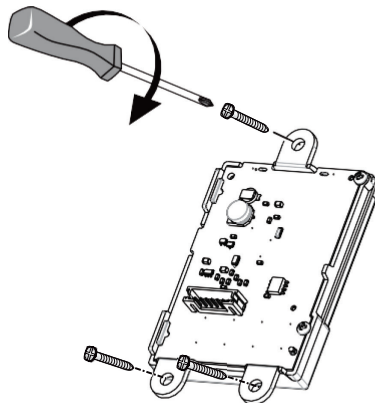

Connection

Connection on the radiator's power card.

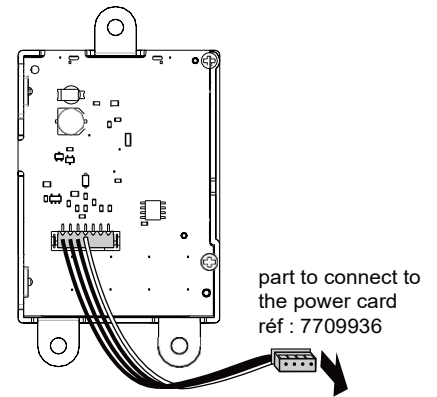

Configuration

When in Off mode, press and hold down the On/Off button for 10 seconds to access the first configuration menu.

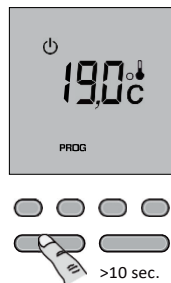

Menu 3: Backlight time out setting

The time out can be adjusted between 0 and 225 seconds, in steps of 15 seconds (set on 90 seconds by default). To modify, press on the + or - buttons then press OK to confirm and go to the next setting.

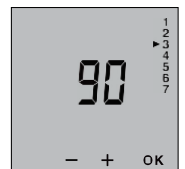

Menu 1: ECO set-point adjustment

By default, Economy setting = Comfort setting - 3.5°C.

This reduction can be set between 0 to -10°C, in steps of 0.5°C.

To adjust the reduction, press on the + or - buttons then press OK to confirm and go to the next setting.

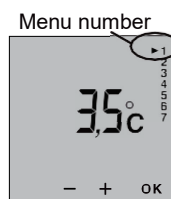

Menu 4: AUTO mode temperature display option

0 = Continuous display of room temperature.
1 = Continuous display of set-point temperature.

To modify, press on the + or - buttons then press OK to confirm and go to the next setting.

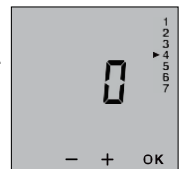

To allow the user to modify the set-point, press on the + button in Economy mode until “----” is displayed on the screen.

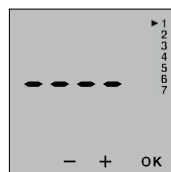

Menu 5: Product number

This menu allows you to view the product number.

To exit the configuration mode, press OK.



Menu 2: Correction of the measured temperature

If there is a difference between the temperature noted (thermometer) and the temperature measured and displayed by the unit, menu 2 acts on the measurement of the probe so as to compensate for this difference (from -5°C to +5°C in steps of 0.1°C).

To modify, press on the + or - buttons then press OK to confirm and go to the next setting.

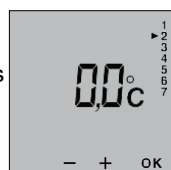

Time Setting

In Off mode, press the  button.

The days flash.

Press + or - to set the day, then press OK to confirm and go on to set the hour and then the minutes.

Press the  button once to access the programming, and press the On/Off button once to exit the setting mode.

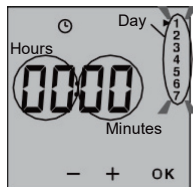

Programming

When starting up, the "Comfort mode from 8am to 10pm" program is applied to all the days of the week.

To change the programming, press the **PROG** button in Off or AUTO mode.

The 1st time slot flashes on and off.

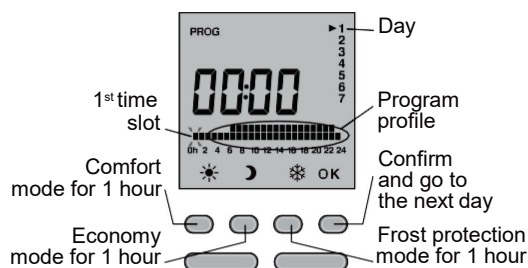



Quick programming:

To apply the same program to the following day, press and hold the OK button for approximately 3 seconds until the program of the following day is displayed.

To exit the programming mode, press on the On/Off button.

Use

The Mode button allows you to select the different operating modes:  Comfort,  Economy,  Frost protection, programming **AUTO** mode.

Pressing the **i** button gives you the temperature of the room or the set-point temperature, according to your configuration settings in menu 5.

If the **ON** icon is displayed, this means that the device is in heating demand mode.

Continuous Comfort

Pressing and holding the + or - buttons lets you change the current set-point (+5 to +30°C) in steps of 0.5°C.



Continuous Economy mode

The Economy set-point is indexed according to the Comfort set-point. The reduction can be modified in the configuration settings for menu 1.



Modifying the Economy set-point

The set-point can be modified if it was authorized in the configuration settings in menu 1 ("---").

Pressing and holding the + or - buttons lets you change the current set-point (+5 to +30°C) in steps of 0.5°C.



Use

Continuous Frost Protection

Pressing and holding the + or - buttons lets you change the current set-point (+5 to +15°C) in steps of 0.5°C.

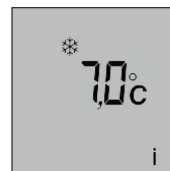

AUTOMATIC mode

In this mode the device follows the programming set.

To modify the programming, press the **PROG** button once.

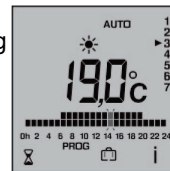

Timer mode

To set a set-point temperature for a certain period of time, press on the  button once.

To set the temperature you want (+5°C to +30°C), use the + and - buttons, then press OK to confirm and go on to set the duration.

To set the duration you want (30 min to 72 hours, in steps of 30 min), use the + and - buttons (e.g. 1 hr 30 min), then press OK. To cancel the timer mode, press on the OK button.



Absence mode

You can set your device to Frost protection mode for a period between 1 and 365 days, by pressing on the  button.

To set the number of days of absence, press on the + or - buttons, then confirm by pressing OK.

To cancel this mode, press on the OK button again.

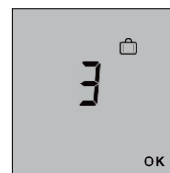

Locking the keypad

If you press and hold the central buttons simultaneously during 5 seconds, it enables you to lock the keypad. A key symbol appears briefly on the display.

To unlock the keypad, press simultaneously on the central buttons.

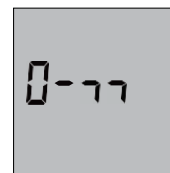

Once the keypad is locked, the key symbol appears briefly if you press on a button.

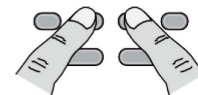

Menu 5: Open Window detection

The detection of an open window occurs when the room temperature falls rapidly. In this case, the display shows a flashing  pictogram, as well as the frost protection set-point temperature.

0 = Open window detection is deactivated
1 = Open window detection is activated

To modify, press on the + or - buttons, then press OK to confirm and to go to the next setting.

Please note: an open window cannot be detected in OFF-Mode.

This feature can be temporarily interrupted by pressing on .

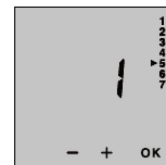

Menu 6: Adaptive start control

This feature enables to reach the set-point temperature at a set time.
When this feature is activated, the display shows a flashing .

0 = Adaptive start control deactivated
1 = Adaptive start control activated

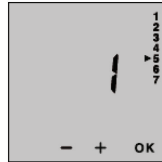

To modify, press on the + or – buttons, then press OK to confirm and to go to the next setting.

Adjusting the time-temperature-slope (when adaptive start control is activated)

From 1°C to 6°C, in steps of 0.5°C.

If the set-point temperature is reached too early, then a lower value should be set.
If the set-point temperature is reached too late, then a higher value should be set.

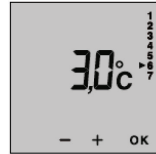

Menu 7: Productnumber

This menu allows you to view the product number.

To exit the configuration mode, press OK.



Technical characteristics

- Power supplied by the power card
- Dimensions in mm (without mounting lugs):
H = 71.7, W = 53, D= 14.4
- Screw-mounted
- Install in an environment with normal pollution levels
- Storage temperature: -10°C to +70°C
- Operating temperature: 0°C to +40°C