

Installation and Operating Instructions

Combination Heater CHM for mounting on walls

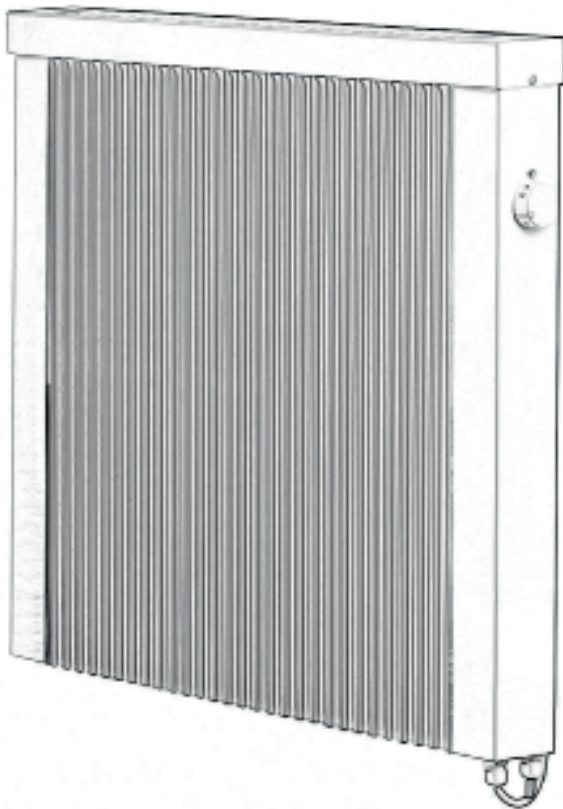

Types

- CHM 500 E
- CHM 1000 E
- CHM 1500 E
- CHM 2000 E

- CHM 500 DSM
- CHM 1000 DSM
- CHM 1500 DSM
- CHM 2000 DSM

- CHM 500 RF
- CHM 1000 RF
- CHM 1500 RF
- CHM 2000 RF



Please read attentively and keep in a safe place!

Subject to alterations!

Id_no. 911 360 514

Issue 01/19

1. General information about our surface storage heaters

With our variety of electric surface storage heaters, you can find the right solution for your needs any spatial situation. The TECHNOTHERM surface storage heaters are available as additional or transitional heating for all rooms in the living area, with the exception of the special cases stated in the safety instructions. They are designed for continuous operation. Prior to dispatch, all our products undergo an extensive function, safety and quality test. We guarantee a constructive design complying with all currently applicable international, European and German safety standards and rules. You can see this in the labelling of our products with the well-known certification marks: “TÜV-GS”, “SLG-GS”, “Keymark”, and “CE”. Our heaters are evaluated in accordance with the internationally applicable IEC-regulations. The manufacture of our heaters is constantly supervised by a state-accredited test centre.

This heater can be used by children aged from 8 years and above and by physically, sensory or mentally restricted persons if they are supervised or given instructions on safe use and understand the hazards involved as it does not require any experience or knowledge.

This device is not a toy for children to play with! Cleaning and user maintenance shall not be carried out by children without supervision. The use of heat radiators is to be given a particular duty of care by supervisors.

Children under the age of 3 are to be kept away unless they are continually supervised. Children between the age of 3 and 8 are only allowed to switch the heater on or off if they are supervised or given instructions on safe use and understand the hazards involved, provided that it has been placed or installed in its intended normal operating position. Children between the age of 3 and 8 shall not plug in, regulate and clean the heater or perform user maintenance.

Caution: Some parts of the product can become very hot and cause burns. Pay particular attention when children and vulnerable people are present. (With the exception of LT series - see separate Instructions!)

2. Directions for use

As soon as the heater is completely assembled and installed by an authorized electrician, you can start using it.

3. Important safety instructions

3.1 Surface storage heaters for dry rooms

The heating devices should only be installed by an authorized and certified electrician in accordance with the applicable provisions of DIN VDE 0100.

Pay particular attention to our warning “Do not cover heater!” Please do not put any flammable objects onto the heater or near it!

The heaters must not be operated in rooms where there is a risk of fire or explosion caused by dust, gases, or vapours. Avoid humid surroundings!

When connecting the heater to a power outlet, select only a safety-socket installed by a certified electrician, because the heaters are protection class I devices that cannot be installed directly in front of or under a wall power outlet.

If the power cable of the heater is damaged, it must be replaced by the manufacturer or its after-sales service or a similarly qualified person, in order to avoid hazards.

In the event of a fixed connection, an all-pole separator with a minimum 3mm contact opening width must be built in.

If you detect damage or an improper function, disconnect the heater from the mains supply. Report the case to our customer service department as soon as possible.

To avoid a fire hazard, keep the following safety distances when mounting the heater:

From the each side wall of the heater to any masonry:	5 cm
From the each side wall of the heater to flammable materials:	10 cm
Distance from the heater to the floor:	8 cm
Distance from the upper edge of the heater to the building component or covers above it (e.g. window sill):	flammable 15 cm non-flammable 10 cm

GB

- To avoid a fire hazard, keep a minimum distance of 40cm from the ceiling or a panel above the heater, when mounting it. What to do in the event of a fault? If the heater does not heat properly, please check first of all whether there is a proper power supply (device plug, if exists, and mains fuse). If the heater still does not work properly, disconnect the device from the power supply and inform our customer service department. Interventions and repairs on the device may only be done by authorized agents.

4. Technical data:

Our surface storage heaters are designed for protection class I and a mains voltage of 230V, 50Hz. For all heater types listed in the table, internal electronic temperature regulators or remote-controlled room temperature regulators are optionally available. Our various products of 34 cm or 63 cm overall height are available in the IP24 version. All other heaters have protection class IP20. Please see the information given on the nameplate of the heater.

Table: Allocation of the heaters to the respective fastening systems and distances between drill holes:

Types	Power [Watt]	Dimensions [cm]		Protection class
CHM 500 E	500	38 x 63 x 7		IP 20
CHM 1000 E	1000	68 x 63 x 7		IP 20
CHM 1500 E	1500	98 x 63 x 7		IP 20
CHM 2000 E	2000	98 x 63 x 7		IP 20
				IP 20
CHM 500 DSM	500	38 x 63 x 7		IP 20
CHM 1000 DSM	1000	68 x 63 x 7		IP 20
CHM 1500 DSM	1500	98 x 63 x 7		IP 20
CHM 2000 DSM	2000	98 x 63 x 7		IP 20
CHM 1000 H DSM	1000	38 x 124 x 7		
				IP 20
CHM 500 RF	500	38 x 63 x 7		IP 20
CHM 1000 RF	100	68 x 63 x 7		IP 20
CHM 1500 RF	1500	98 x 63 x 7		IP 20
CHM 2000 RF	2000	98 x 63 x 7		IP 20

GB

5. Installation instructions

Please observe the safety instructions given on page 3!

- Our electric partial surface thermal-storage heaters shall be preferably mounted under a window or close to a room load-bearing wall (please absolutely keep the minimum clearances as shown on page 4).
- The respective fastening components and aids are an integral part of the delivery.
- The room thermostat shall be placed at half of the room height and not closer than 1 meter from the heaters. The thermostat is to be installed between the power source and the electric storage heater. Remove the packaging. Heed that no packaging residues stick on the heater! Using the Table on page 5, please select the fastening system appropriate for the dimensions of your heater! The table and the sketches below show the distances of the drill holes to be made (Ø 8mm, depth 45mm). Mount U-rails on the wall!

GB

5.1. Wall mounting

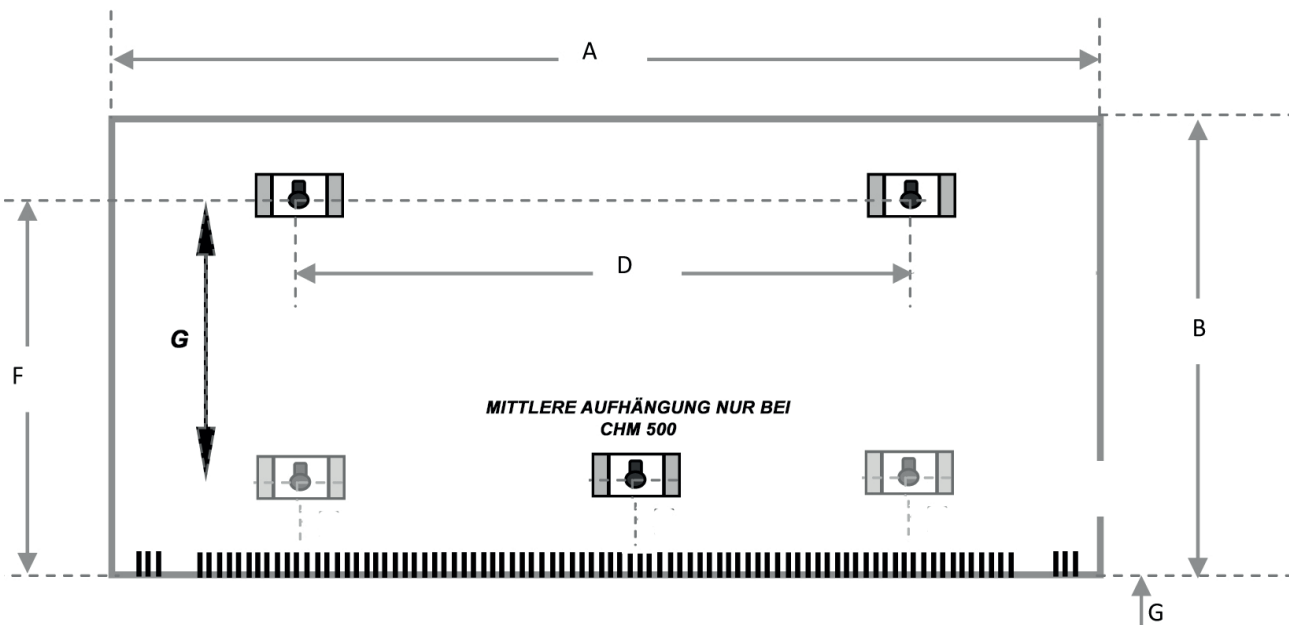

GB

Model	Power [Watt]	Width A [mm]	Hight B [mm]	Deep C [mm]	D [mm]	F [mm]	G [mm]
CHM 500	500	380	630	100	186	521	445
CHM 1000	1000	680	630	100	336	506	430
CHM 1500	1500	980	630	100	500	506	430
CHM 2000	2000	980	630	100	500	506	430
CHM 1000 H	1000	380	1240	100	186	521	445

Please note: You recognize the device bottom by a protruding power supply cable.

6. Report the case to the after-sales service

Your surface storage heater was carefully manufactured and checked repeatedly before dispatch. If you should nevertheless encounter a problem or have questions concerning handling, feel free to contact us.

From Jan 1st 2018, the EU-conformity of these devices is additionally bound to fulfilment of the Eco-Design Requirements 2015 /1188.

Installation and starting up of the equipment is only permitted in conjunction with external room temperature controllers which fulfil the following functions:

GB

- electronic room temperature control depending on the weekday

and, at least, has one of the following characteristics:

- Room temperature control with detection of an opened window
- With remote control option
- With adaptive start control

The following room temperature control systems supplied by ecostrad

- DSMTthermostat
- RF Thermostate

fulfil the following requirements and thus the ErP Directive:

- electronic room temperature control depending on the weekday
- with detection of an opened window
- adaptive control of the heating start

The use of the standard CHM (without an external thermostat regulating) is only permitted with castors or on feet.

For installation and use of the Technotherm thermostats and interfaces, please refer to a separate manual. The manual can be requested at the Customer Service - see the last page.

If this requirement is not fulfilled, the device will lose its CE marking.

-

7. Guideline

Information requirements for electrical room heaters

Type: CHM DSM (optional with the DSM interface)													
Designation	Symbol	Rate									Unit	Designation	Unit
Heating capacity											Type of heat supply, only for electrical storage heaters in rooms (select one type)		
Nominal thermal output	P_{nom}	0.5	1.0	1.2	1.5	1.8	2.0				kW	Manual thermal charge control, with integrated thermostat	NO
Minimal thermal output (indicative)	P_{min}	0.5	1.0	1.2	1.5	1.8	2.0				kW	Manual thermal charge control with acknowledgement of the room inside and /or outside temperature	NO
Maximum continuous thermal performance	$P_{max,c}$	0.5	1.0	1.2	1.5	1.8	2.0				kW	Electronic charge control with acknowledgement of the room inside and /or outside temperature	NO
Auxiliary current consumption												Heating power supported with a fan	NO
At nominal thermal output	eI_{max}	0.5	1.0	1.2	1.5	1.8	2.0				kW	Type of heating power / room temperature Control (select one type)	
At the minimum heating capacity	eI_{min}	0.8	0.8	0.8	0.8	0.8	0.8				Watt	Single-stage heating capacity; no room temperature control	NO
At the standby mode	eI_{sb}	0.8	0.8	0.8	0.8	0.8	0.8				Watt	Two or more manual stages, no room temperature control	NO
												With mechanical room temperature control	NO
												With electronic room temperature control	NO
												Electronic temperature control in the room, depending on the time of day	NO
												Electronic temperature control in the room, depending on the weekday	YES
												Other control options (multiple choice is possible)	
												Room temperature control with presence detection	NO
												Room temperature control with detection of an opened window	YES
												With remote control option	NO
												With adaptive start control	YES
												With limitation of heating time	NO
												With a black lamp sensor	NO
Contact	Lucht LHZ Elektroheizung GmbH & Co. KG Reinhard-Schmidt.Str.1 D-09217 Burgstädt, Germany												
Type: CHM RF (additional thermostat TPF-Eco and Eco interface is required)													
Designation	Symbol	Rate									Unit	Designation	Unit
Heating capacity											Type of heat supply, only for electrical storage heaters in rooms (select one type)		
Nominal thermal output	P_{nom}	0.5	1.0	1.2	1.5	1.8	2.0				kW	Manual thermal charge control, with integrated thermostat	NO
Minimal thermal output (indicative)	P_{min}	0.5	1.0	1.2	1.5	1.8	2.0				kW	Manual thermal charge control with acknowledgement of the room inside and /or outside temperature	NO
Maximum continuous thermal performance	$P_{max,c}$	0.5	1.0	1.2	1.5	1.8	2.0				kW	Electronic charge control with acknowledgement of the room inside and /or outside temperature	NO
Auxiliary current consumption												Heating power supported with a fan	NO
At nominal thermal output	eI_{max}	0.5	1.0	1.2	1.5	1.8	2.0				kW	Type of heating power / room temperature Control (select one type)	
At the minimum heating capacity	eI_{min}	2	2	2	2	2	2				W	Single-stage heating capacity; no room temperature control	NO
At the standby mode	eI_{sb}	0.47	0.47	0.47	0.47	0.47	0.47				W	Two or more manual stages, no room temperature control	NO
												With mechanical room temperature control	NO
												With electronic room temperature control	NO
												Electronic temperature control in the room, depending on the time of day	NO
												Electronic temperature control in the room, depending on the weekday	YES
												Other control options (multiple choice is possible)	
												Room temperature control with presence detection	NO
												Room temperature control with detection of an opened window	NO
												With remote control option	YES
												With adaptive start control	NO
												With limitation of heating time	NO
												With a black lamp sensor	NO
Contact	Lucht LHZ Elektroheizung GmbH & Co. KG Reinhard-Schmidt.Str.1 D-09217 Burgstädt, Germany												

GB

Digital control display TDI – “plus” Thermostat

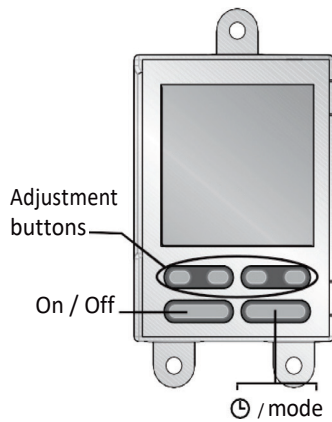

Mounting

Mounted on the side of the radiator using screws.

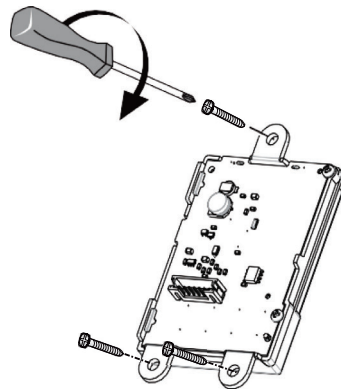

Connection

Connection on the radiator's power card.

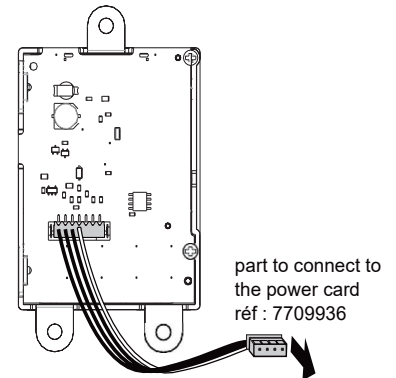

GB

Configuration

When in Off mode, press and hold down the On/Off button for 10 seconds to access the first configuration menu.

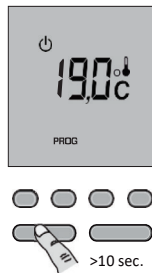

Menu 3: Backlight time out setting

The time out can be adjusted between 0 and 225 seconds, in steps of 15 seconds (set on 90 seconds by default). To modify, press on the + or - buttons then press OK to confirm and go to the next setting.

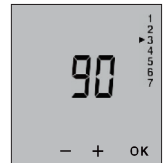

Menu 1: ECO set-point adjustment

By default, Economy setting = Comfort setting - 3.5°C.

This reduction can be set between 0 to -10°C, in steps of 0.5°C.

To adjust the reduction, press on the + or - buttons then press OK to confirm and go to the next setting.

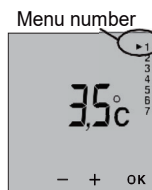

Menu 4: AUTO mode temperature display option

0 = Continuous display of room temperature.
1 = Continuous display of set-point temperature.

To modify, press on the + or - buttons then press OK to confirm and go to the next setting.

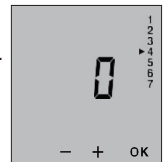

To allow the user to modify the set-point, press on the + button in Economy mode until "----" is displayed on the screen.

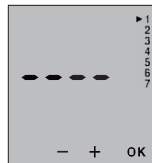

Menu 5: Product number

This menu allows you to view the product number.

To exit the configuration mode, press OK.



Menu 2: Correction of the measured temperature

If there is a difference between the temperature noted (thermometer) and the temperature measured and displayed by the unit, menu 2 acts on the measurement of the probe so as to compensate for this difference (from -5°C to +5°C in steps of 0.1°C).

To modify, press on the + or - buttons then press OK to confirm and go to the next setting.

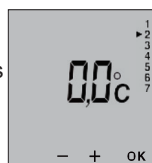

Time Setting

In Off mode, press the mode button.

The days flash.

Press + or - to set the day, then press OK to confirm and go on to set the hour and then the minutes.

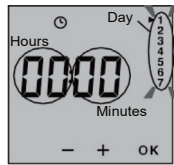

Press the mode button once to access the programming, and press the On/Off button once to exit the setting mode.

Programming

When starting up, the "Comfort mode from 8am to 10pm" program is applied to all the days of the week.



To change the programming, press the PROG button in Off or AUTO mode.

The 1st time slot flashes on and off.

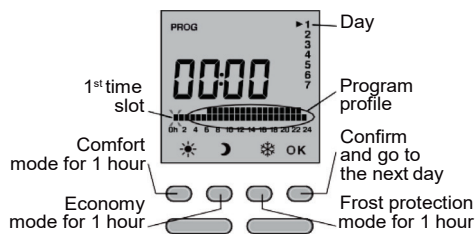

Quick programming:

To apply the same program to the following day, press and hold the OK button for approximately 3 seconds until the program of the following day is displayed.

To exit the programming mode, press on the On/Off button.

Use

The Mode button allows you to select the different operating modes: ☀ Comfort, 🌙 Economy, ❄ Frost protection, programming **AUTO** mode.

Pressing the **i** button gives you the temperature of the room or the set-point temperature, according to your configuration settings in menu 5.

If the **ON** icon is displayed, this means that the device is in heating demand mode.

Continuous Comfort

Pressing and holding the + or - buttons lets you change the current set-point (+5 to +30°C) in steps of 0.5°C.



Continuous Economy mode

The Economy set-point is indexed according to the Comfort set-point. The reduction can be modified in the configuration settings for menu 1.



Modifying the Economy set-point

The set-point can be modified if it was authorized in the configuration settings in menu 1 ("----").

Pressing and holding the + or - buttons lets you change the current set-point (+5 to +30°C) in steps of 0.5°C.



Use

Continuous Frost Protection

Pressing and holding the + or - buttons lets you change the current set-point (+5 to +15°C) in steps of 0.5°C.

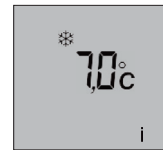

AUTOMATIC mode

In this mode the device follows the programming set.

To modify the programming, press the **PROG** button once.

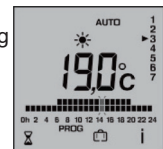

Timer mode

To set a set-point temperature for a certain period of time, press on the ⌚ button once.

To set the temperature you want (+5°C to +30°C), use the + and - buttons, then press OK to confirm and go on to set the duration.

To set the duration you want (30 min to 72 hours, in steps of 30 min), use the + and - buttons (e.g. 1 hr 30 min), then press OK.

To cancel the timer mode, press on the OK button.



Absence mode

You can set your device to Frost protection mode for a period between 1 and 365 days, by pressing on the 📅 button.

To set the number of days of absence, press on the + or - buttons, then confirm by pressing OK.

To cancel this mode, press on the OK button again.

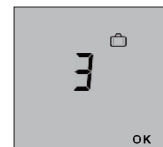

Locking the keypad

If you press and hold the central buttons simultaneously during 5 seconds, it enables you to lock the keypad. A key symbol appears briefly on the display.

To unlock the keypad, press simultaneously on the central buttons.



Once the keypad is locked, the key symbol appears briefly if you press on a button.

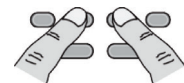

Menu 5: Open Window detection

The detection of an open window occurs when the room temperature falls rapidly. In this case, the display shows a flashing ❄ pictogram, as well as the frost protection set-point temperature.

0 = Open window detection is deactivated
1 = Open window detection is activated

To modify, press on the + or - buttons, then press OK to confirm and to go to the next setting.

Please note: an open window cannot be detected in OFF-Mode.
This feature can be temporarily interrupted by pressing on ❄.

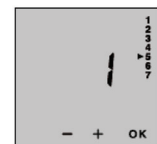

GB

Menu 6: Adaptive start control

This feature enables to reach the set-point temperature at a set time.
When this feature is activated, the display shows a flashing .

0 = Adaptive start control deactivated

1 = Adaptive start control activated

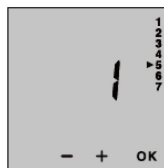

To modify, press on the + or – buttons, then press OK to confirm and to go to the next setting.

Adjusting the time-temperature-slope (when adaptive start control is activated)

From 1°C to 6°C, in steps of 0.5°C.

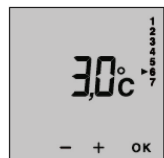

If the set-point temperature is reached too early, then a lower value should be set.
If the set-point temperature is reached too late, then a higher value should be set.

GB

Menu 7: Productnumber

This menu allows you to view the product number.

To exit the configuration mode, press OK.



Technical characteristics

- Power supplied by the power card
- Dimensions in mm (without mounting lugs):
H = 71.7, W = 53, D= 14.4
- Screw-mounted
- Install in an environment with normal pollution levels
- Storage temperature: -10°C to +70°C
- Operating temperature: 0°C to +40°C

TECHNOTHERM After-sales service:
Ph. +49 911 93 78 32 10

Technical alternations, errors, omissions and errata reserved. Dimensions are stated without warranty!

Updated: April 18

TECHNOTHERM is a trademark of Lucht LHZ GmbH & Co. KG
Reinhard Schmidt-Str. 1 | 09217 Burgstädt, Germany
Phone: +49 3724 66869 0
Telefax: +49 3724 66869 20
info@technotherm.de | www.technotherm.de